



Calcasieu Parish Sheriff's Office

TONY MANCUSO, SHERIFF AND EX-OFFICIO TAX COLLECTOR

Parish of Calcasieu • 5400 E. Broad Street • Lake Charles, LA 70615
Phone (337) 491-3700 • Fax (337) 494-4522

QUOTE REQUEST

Individual Requesting Quote: Dana Dawkins Project Name: _____
 Quote Due Date & Time: March 5, 2021 10:00 am Project Director: Dana Dawkins
 Date of Request: _____ Project Start Date: March 8, 2021
 Department: _____ Project Completion Date: _____
 Phone Number: 904-832-3097 Grant Name & #: N/A

All responses to this quote solicitation must be completed using this form and must be transmitted using one of the three delivery options below:

1. Physical Delivery: Accounting – 1101 Lakeshore Drive, Floor 6 Suite 606, Lake Charles, LA 70601

ALL OTHER TRANSMISSIONS WILL NOT BE ACCEPTED OR HONORED.

The Calcasieu Parish Sheriff's Office is requesting detailed, itemized, written quotes for the following scope of work/project: **Moss Bluff Building (Asset #010-001)**

Scope of work/Project Description: **See Attached**

Specific insurance will be required will not be required for the completion of the scope of work/project above. If specific insurance will be required, please see attached insurance requirements.

A separate contract will be required will not be required prior to completion of the scope of work/project above. If separate contract is not required, this quote request will become the contract.

Any public works contract (as defined by **LA R.S. 38:2211(12)**) which is greater than **\$25,000** requires a **100% payment and performance bond**. Any quotes greater than or equal to the following shall be delivered in a sealed envelope to Purchasing with an applicable Louisiana Contractor's License number printed on the outside of the envelope: **\$50,000** for public works; **\$10,000** for electrical and mechanical; and **\$1** for hazardous materials.

Vendor's Price Quote Excluding Taxes: \$ _____ If requested, the Calcasieu Parish Sheriff's Office will provide a tax-exempt certificate. Quotes must be inclusive of all costs (material, labor, installation, FOB destination, freight prepaid & allowed, any rentals, fees if required, etc).

Quote effective from: _____ to _____

Quote submitted by: _____
Company Name

Company Phone Number: _____ Fax Number: _____

Signature of Person Submitting Quote

Name Printed

Exhibit A – CPSO Moss Bluff (Asset #010-001)

1. Scope of Work/Specifications – Attached
2. Insurance Requirements – Attached
3. Mandatory site visit to confirm scope/specifications – Attached
4. Start Date: March 8, 2021
5. Price to include disposal of materials. Dumpster cost and disposal fees to be included in price.

SECTION 01010

SUMMARY OF WORK

PART 1 GENERAL

1.01 SUMMARY

- A. Project Summary:
Calcasieu Parish Sheriff's Office
115 Bronco Lane

MOSS BLUFF SUB-STATION (ASSET #010-001)

EXTERIOR (Front)

- | | |
|---|-----------|
| 1. Remove & Replace Gutter / downspout – aluminum – 6” | 111.00 LF |
| 2. Remove & Replace Roll-up door & hardware - 8 x 8' - 26 gauge | 1.00 EA |

EXTERIOR (Rear)

- | | |
|--|-----------|
| 3. Remove & Replace Gutter / downspout – aluminum – 6” | 111.00 LF |
| 4. Remove & Replace Wall/roof panel - ribbed – 26 gauge - 1 1/8" to 1 1/2"
Damaged on the rear elevation near the back door | 72.00 SF |

EXTERIOR (Right)

- | | |
|--|----------|
| 5. Remove & Replace Rigid conduit, 3” | 16.00 LF |
| 6. Remove & Replace Rigid conduit, 3
Detach and reset from the generator to the box some will need replaced | 20.00 LF |
| 7. Remove & Replace Rigid conduit, 1”
Damaged by the Pavilion | 8.00 LF |
| 8. Remove & Replace Eave trim for metal roofing - 26 gauge | 8.00 LF |

LOBBY

- | | |
|---|-----------|
| 9. Clean suspended ceiling grid | 230.75 SF |
| 10. Remove & Replace Suspended ceiling tile - 2' x 4” | 230.75 SF |

SECTION 01010

SUMMARY OF WORK

HVAC

- | | |
|---|----------|
| 11. Clean suspended ceiling grid | 41.38 SF |
| 12. Remove & Replace Suspended ceiling tile - 2' x 4" | 41.38 SF |

CONFERENCE ROOM

- | | |
|---|-----------|
| 13. Clean suspended ceiling grid | 541.78 SF |
| 14. Remove & Replace Suspended ceiling tile - 2' x 4" | 541.78 SF |

KITCHEN

- | | |
|---|-----------|
| 15. Clean suspended ceiling grid | 183.77 SF |
| 16. Remove & Replace Suspended ceiling tile - 2' x 4" | 183.77 SF |

SECTION 01010

SUMMARY OF WORK

- A. Particular project requirements: No disruption to normal operations of occupants, if occupied.
- B. Permits: Apply for, obtain, and pay for permits required to perform the work. Submit copies to Owner.
- C. Codes: Comply with applicable codes and regulations of authorities having jurisdiction. Submit copies of inspection reports, notices and similar communications to Owner.
- D. Dimensions/Plans: Contractor is responsible to field verify all dimensions, locations and penetrations.
- E. Existing Conditions: Notify Owner of existing conditions differing from those indicated on the drawings. Do not remove or alter structural components without prior written approval.
- F. Definition for terms used in the Specifications:
 - 1. Provide: Furnish and install, complete with all necessary accessories, ready for intended use. Pay for all related costs.
 - 2. R&R: Remove and Replace.
 - 3. Approved: Acceptance of item submitted for approval. Not a limitation or release for compliance with the Contract Documents or regulatory requirements. Refer to limitations of "Approved" in General and Supplementary Conditions.
 - 4. Match Existing: Match existing as acceptable to the Owner.
 - 5. Intent: Drawings and Specifications are intended to provide the basis for proper completion of the work suitable for the intended use of the Owner. Anything not expressly set forth, but which is reasonable implied or necessary for proper performance of the project shall be included.
 - 6. Writing Style: Specifications are written in the imperative mode. Except where specifically intended otherwise, the subject of all imperative statements is the Contractor. For example, "Provide tile" means Contractor shall provide tile.

PART 2 - PRODUCTS - Not applicable to this Section.

PART 3 - EXECUTION - Not applicable to this Section.

END OF SECTION

SECTION 01010

SUMMARY OF WORK

Contractor is responsible to field verify all dimensions and penetrations.

LOBBY:

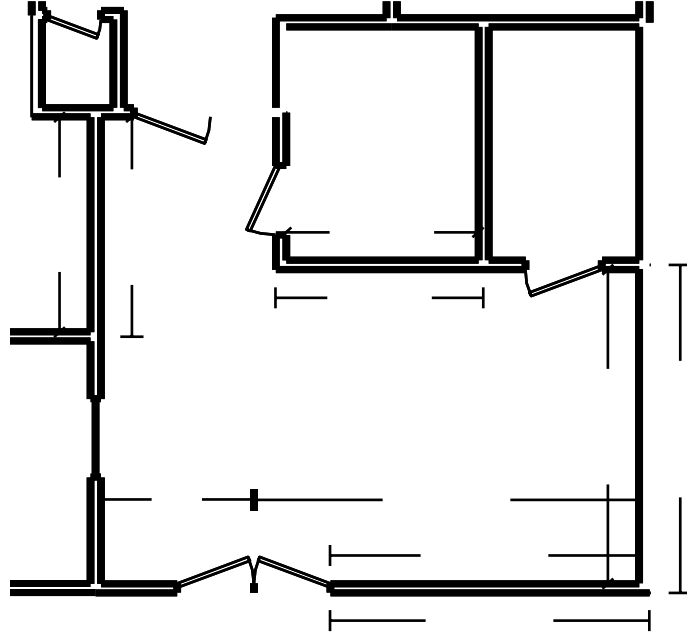

HVAC Room:

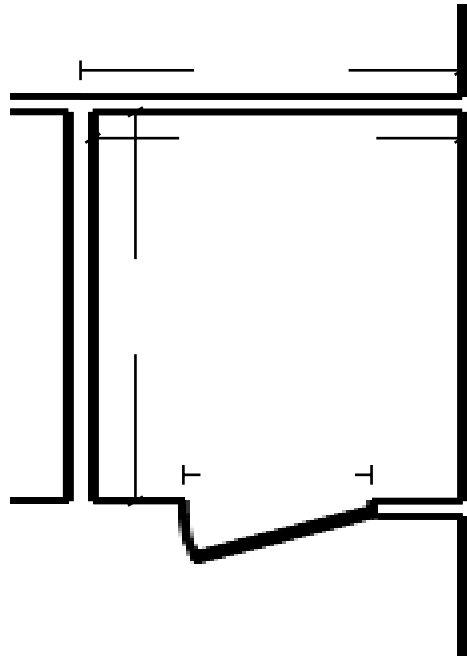

SECTION 01010

SUMMARY OF WORK

Contractor is responsible to field verify all dimensions and penetrations.

RESTROOM 1:

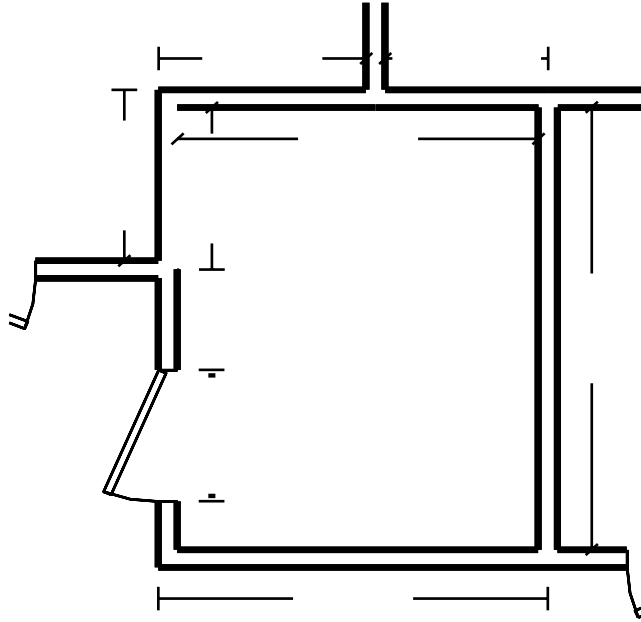

RESTROOM 2:

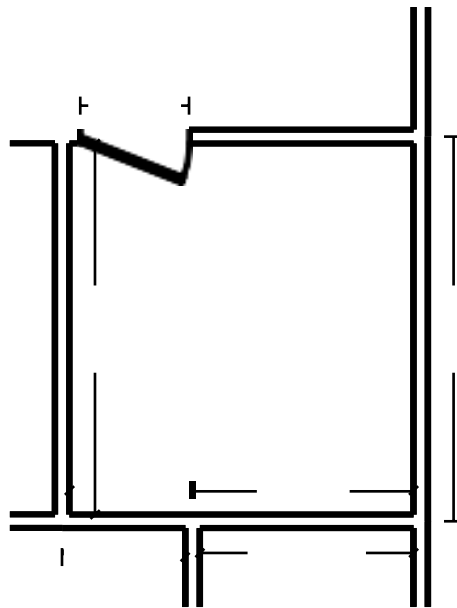

SECTION 01010

SUMMARY OF WORK

Contractor is responsible to field verify all dimensions and penetrations.

CONFERENCE ROOM:

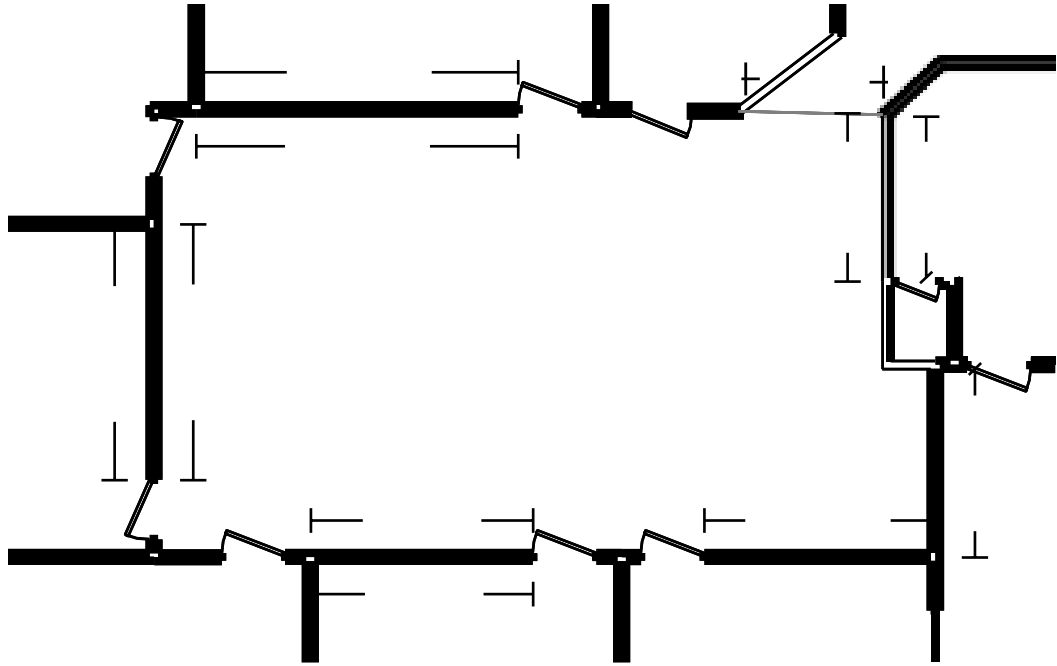

OFFICE 1:

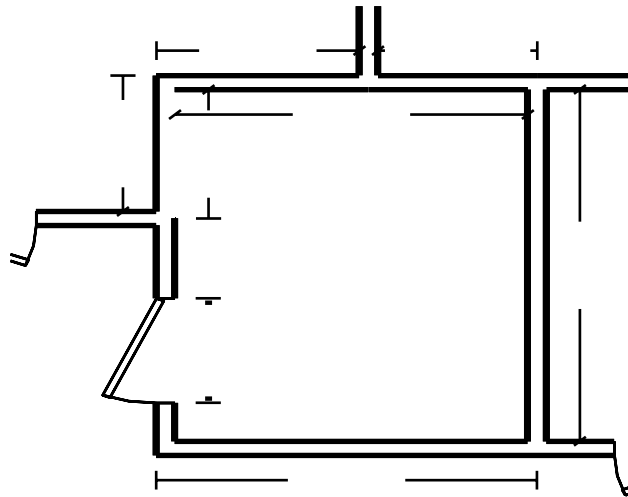

SECTION 01010

SUMMARY OF WORK

Contractor is responsible to field verify all dimensions and penetrations.

RECEPTION ROOM:

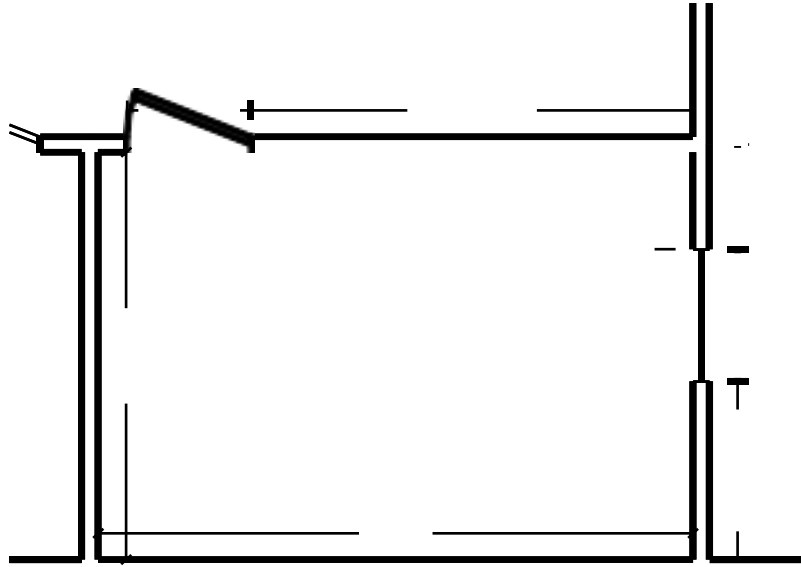

OFFICE 2:

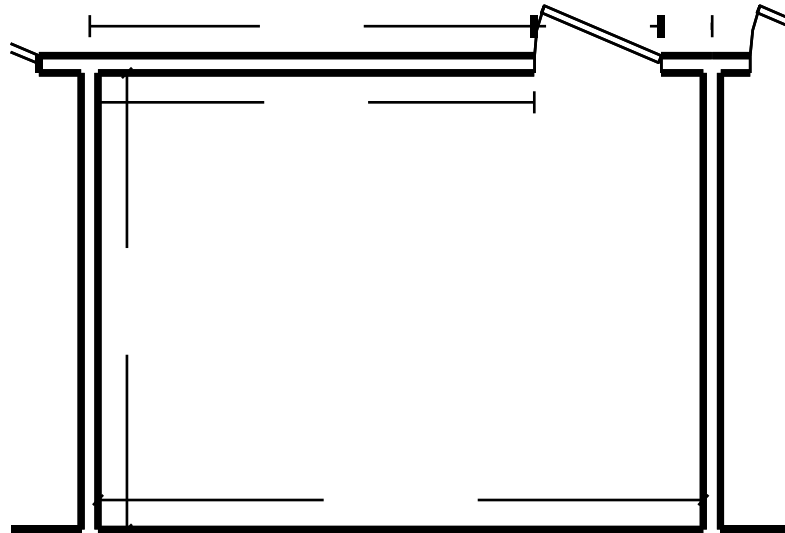

SECTION 01010

SUMMARY OF WORK

Contractor is responsible to field verify all dimensions and penetrations.

OFFICE 3:

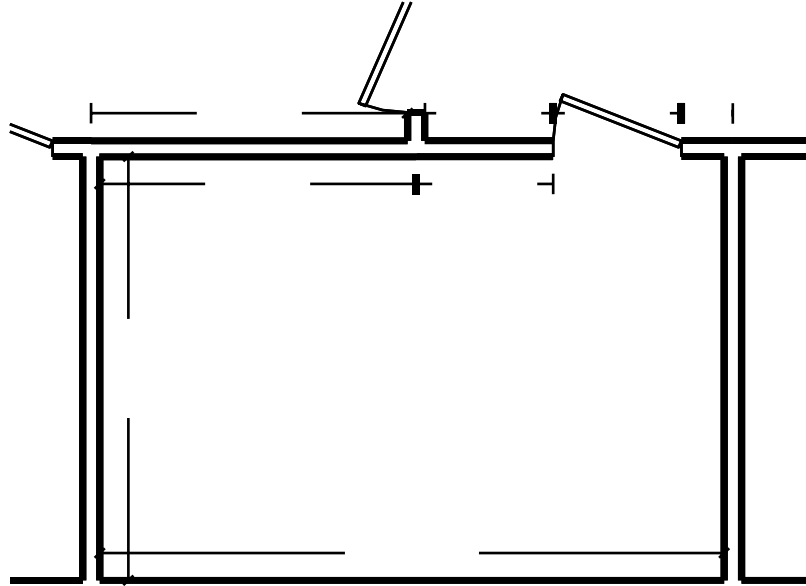

OFFICE 4:

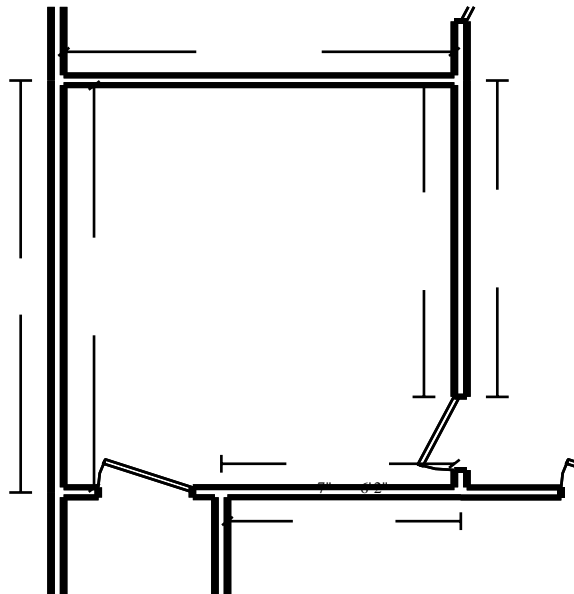

SECTION 01010

SUMMARY OF WORK

Contractor is responsible to field verify all dimensions and penetrations.

OFFICE 5:

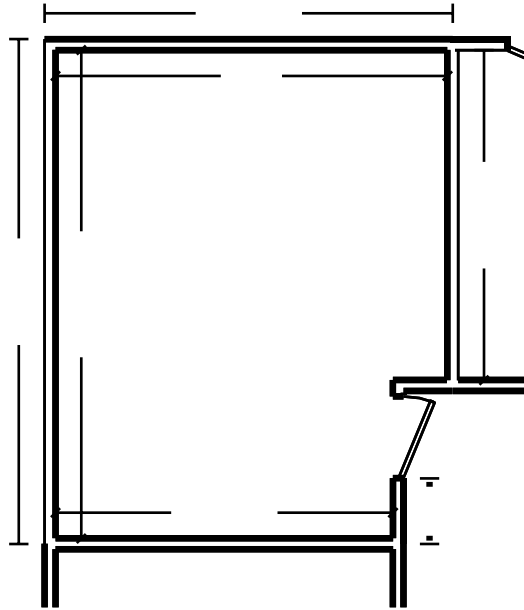

OFFICE 6:

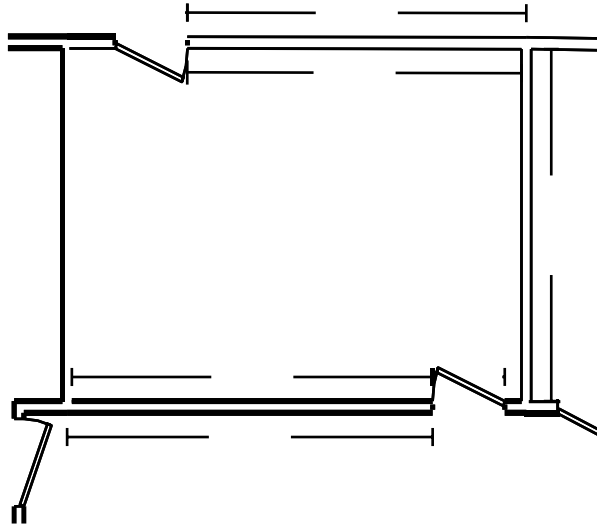

SECTION 01010

SUMMARY OF WORK

Contractor is responsible to field verify all dimensions and penetrations.

OFFICE 7:

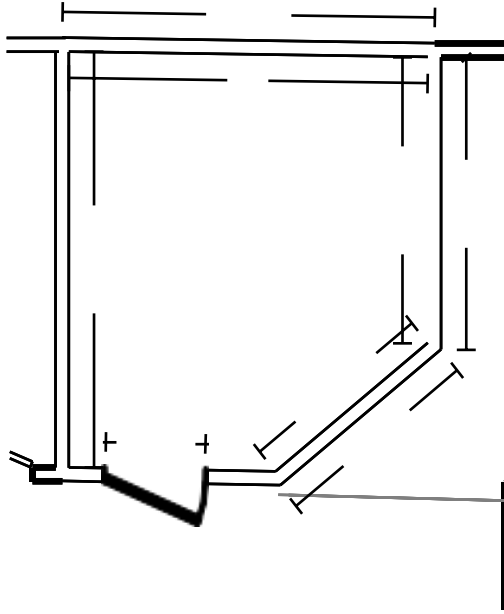

CLOSET 1:

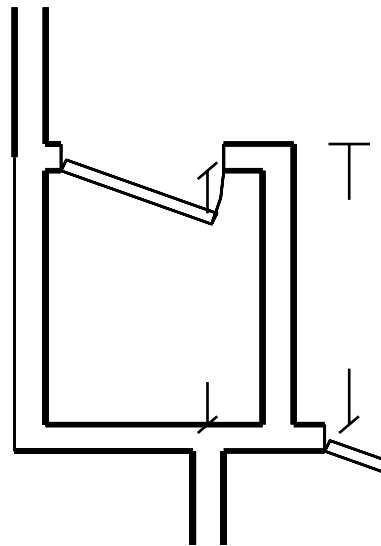

SECTION 01010

SUMMARY OF WORK

Contractor is responsible to field verify all dimensions and penetrations.

STORAGE AREA/ROOM:

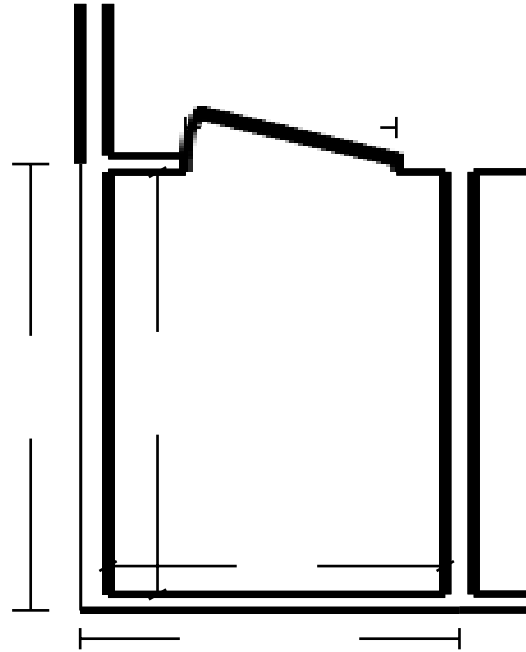

KITCHEN:

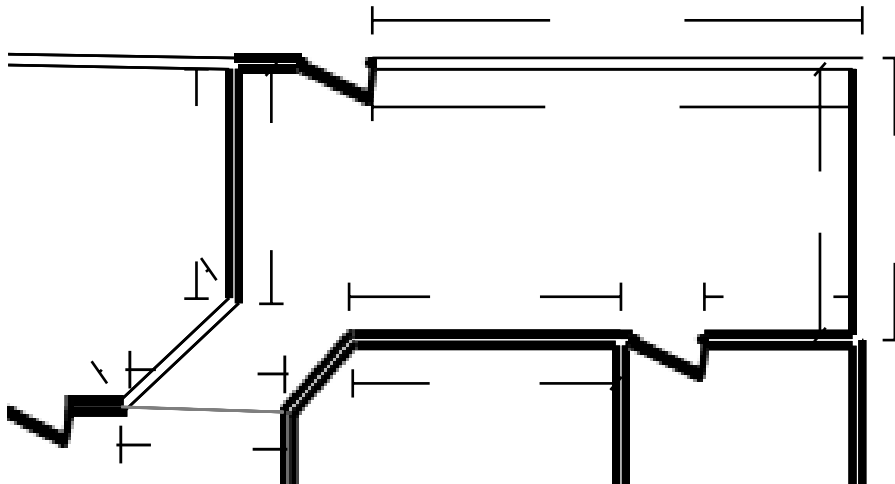

Calcasieu Parish Sheriff's- Insurance Requirements for Projects Twenty-Five Thousand and Greater

Where applicable, any Contractor, Subcontractor, Consultant, Architect, Engineer, Other Professional or Vendor (herein after referred to as Contractor collectively), who performs services for the Owner in the amount of twenty-five thousand dollars or greater shall maintain the following insurance coverage with insurance companies acceptable to the Owner. Those insurance companies must be rated by A.M. Best Rating Guide with an A-VII rating or better. In the event that insurance requirements are included elsewhere within any other procurement documents, the requirements contained within this article shall supersede any such reference.

In connection therewith, the Contractor agrees to provide to the Owner, at the Contractor's expense and prior to any entry on the Owner's property, proof of casualty insurance, including workers compensation, coverage set forth. The Contractor agrees to furnish to the Owner certificates evidencing said insurance coverage for the full terms of this agreement which certificates shall name the Owner as an Additional Insured on all policies except workers compensation and professional liability policies. The Additional Insured endorsement specific to General Liability coverage shall include both on-going and completed operations coverage. The additional insured endorsements shall be at least as broad as the Insurance Services Offices forms CG 20 10 and CG 20 37, 07/04 edition forms, through the period of repose. All policies except for professional liability policies, shall include a Waiver of Subrogation in favor of the Owner and shall be evidenced on the certificate. Notice of cancellation shall be provided in accordance with policy cancellation provisions. Insurance provided shall be primary and non-contributory.

The Contractor agrees to maintain the coverage limits and endorsements as listed herein. The Contractor's obligation to provide the required insurance will not be waived by the Contractor's failure to provide the certificate of insurance, the Owner's acceptance of a certificate of insurance showing coverage varying from the required coverage, or the Owner's allowance to commence work.

No work shall commence under any contract until the following insurance coverage is obtained, by the Contractor:

(1) Worker's Compensation

(a) Standard Louisiana Coverage (Always Required)- Worker's Compensation Coverage:

- (i) Should cover all employees, including owners, (ii) must be statutory for medical and indemnity and (iii) should have a minimum limit for employer's liability of:

Employer's Liability -	\$1,000,000 per accident
	\$31,000,000 each employee - disease
	\$1,000,000 policy limit - disease

(b) USL & H or Jones Act Coverage (depending on the body of water)

Required Not Required

When specifically required by the Owner (as denoted with an "X" in the above "Required" box), the Contractor shall procure and maintain during the life of this contract Worker Compensation specifically covering maritime activities. The scope of the project will determine whether maritime insurance is required but if the project is going to be performed over any body of water then this separate coverage should be obtained.

(2) Comprehensive General Liability Insurance (Always Required)

The term Contractor refers collectively, where applicable, to any Contractor, Subcontractor, Consultant, Architect, Engineer or Vendor performing services for the Owner.

(a) Comprehensive General Liability ("Claims Made Policies" may not be used)

\$1,000,000 per occurrence
\$2,000,000 general aggregate (Q Limit applies to specific project^] Limit applies to policy)
\$1,000,000 products/ completed operations aggregate \$1,000,000 personal injury and advertising coverage

Sub: Comprehensive General Liability

Any Sub Contractors utilized will be X Required Not Required to maintain the above comprehensive general liability policy limits.

(b) Automobile Liability (Owner, Non-Owned, and Hired Car)

\$1,000,000 per occurrence Sub:

Automobile liability

Any Sub Contractors utilized on the project will be X Required ___ Not Required
to maintain the above automobile liability policy limit

(c) Umbrella Policy

Unless specifically excluded for project specific reasons, the Contractor shall procure and Maintain during the life of this contract an Umbrella Policy as follows:

\$5,000,000 each occurrence Coverage Specifically Excluded for this Project
\$5,000,000 general aggregate

(3) Owner's Contractor Protective Liability Policy (OCP Policy)

Required X Not Required

When specifically required by the Owner (as denoted with an "X" in the above "Required" box), The Contractor shall procure and maintain during the life of this contract an Owner's Contractor Protective Liability Policy (OCP) in a minimum amount of \$1,000,000 (per occurrence) and \$2,000,000 (general aggregate). This type of policy provides the Owner with separate coverage up to the above limits as opposed to shared coverage when the Owner is only named as an additional insured on the Contractors main policy.

(4) Property Insurance (Builder's Risk Insurance)

___ Required X Not Required

Coverage shall be All Risk, **Including Flood. A separate NFIP policy will be allowed.**

When specifically required by the Owner (as denoted with an "X" in the above "Required" box), the Contractor shall purchase and maintain property insurance covering the work site up to the full insurable value equal to the Contract sum and the insurance shall be endorsed to comply with any waiver of rights provisions. The property insurance shall be "All Risks Builder's Risk Completed Value Form" insurance or equivalent manuscript policy, and shall include without limitation, insurance against all perils.

The property insurance shall also contain an endorsement or specific provision to cover damages, losses and expenses incurred in the repair or replacement of any insured property (including, but

not limited to charges of engineers, architects, attorneys and others). The Property insurance also shall include by endorsement or special provision the following additional coverage elections: operational testing (if risk is present), off premises storage not on the site or in transit and property in transit. When required, no work may commence on the site until the Builder's Risk Insurance is obtained.

The Contractor is to provide Builder's Risk Insurance to protect the Owner, Architect, Engineer, Contractor, and any Subcontractors as to any interests that may exist. Until acceptance of work by the Owner, all work in connection with a particular contract is in the custody, charge and care of the Contractor who will take every necessary precaution against injury or damage to any part thereof whether arising from execution or from the non-execution of the work.

Contractor shall be responsible for payment of the deductible for Builder's Risk Insurance or any other property coverage deemed required to be purchased for this Contract, whether acquired by the owner or otherwise.

(5) Errors & Omissions Policy (Professional Liability Insurance)

(Applicable Only to Professional Services Contracts including, but not limited to, Architect, Engineer, Consultant or Other Professional Contracts)

Required Not Required

This policy covers negligent acts, errors and omissions in its performance of professional Services with minimum policy limits of \$1,000,000 per claim and \$1,000,000 general aggregate.

Section B - Other Insurance Requirements

(1) Additional Insured Classification and Waiver of Subrogation (Always Required)

The Owner must be listed as an additional insured on all policies except for worker's compensation and professional liability insurance policies. All policies will provide notice of cancellation in accordance with policy provisions. Waiver of subrogation will be given to the Owner on all policies, which means that the Contractor's insurer(s) will have no right of recovery or subrogation against the Owner.

Except for professional liability insurance, it is the intention of the parties that the insurance policy shall protect both parties and be PRIMARY AND NON-CONTRIBUTORY COVERAGE for any and all losses covered. Again, all policies required above shall be primary to any insurance carried by the Owner. The insurance companies shall have no recourse against the Owner for payment of any premiums or for assessments under any of the above policies.

(2) Indemnification for all Contractors, Except for Architects, Engineers or Other Licensed Professionals (Always Required)

The Contractor will indemnify, defend, and hold harmless the owner, including the owner's employees and agents, from and against any and all claims or liabilities, arising from the fault of the Contractor, its employees, subcontractors or agents in carrying out the Contractor's duties and obligations under the terms of this agreement. This section will survive the termination of any agreement. In the event that either party takes any action to enforce this mutual indemnity provision, the prevailing party shall be entitled to recover reasonable attorney's fees and costs arising as a result thereof.

(3) Indemnification for Architects, Engineers or Other Licensed Professionals (Always Required)

The Contractor will indemnify and hold harmless the owner, including the owner's employees and agents, from and against any and all claims or liabilities, arising from the fault of the Contractor, its employees, subcontractors or agents in carrying out the Contractor's duties and obligations under the terms of this agreement. This section will survive the termination of any agreement. In the event that either party takes any action to enforce this mutual indemnity provision, the prevailing party shall be entitled to recover reasonable attorney's fees and costs arising as a result thereof.

CPSO Moss Bluff (Asset #010-001)

February 16, 2021 10:30 am Mandatory Site Visit to Confirm
Scope/Specifications

Dana Dawkins Construction Manager 904-832-3097 ddawkins@cmtslc.com

if not available

Gary Morgan CPSO 337-263-4537 gmorgan@cpso.com